



Spirit-FLEX™ Tension Systems



A simple, versatile tension banner system for the perfect display installation.

Our Spirit-FLEX™ Tension System is one of the most popular choices for the professional, durable installation of banners, flex-face and other printed flex media including mesh and canvas. A cost-effective, easy-to-use and versatile product, our Spirit-FLEX™ tension banner frames can be manufactured to any size and shape, always giving you an exceptional finish.

Product Details

Spirit-FLEX™ is a 2-part clip system for tensioning and fixing PVC banner vinyl and mesh. The base aluminium frame is mitre cut and fixed to the base structure. The banner is then stretched over the frame and the tension strip 'clip' profile is hammered into the base channel clipping the banner in place and simultaneously creating the tension. Banners require no finishing and are just printed with 100mm (4") bleed which is trimmed off after installation.

Product Specifications

- ✓ Supplied in 3060mm lengths
- ✓ Popular profiles stocked in black and white
- ✓ Wide range of base profiles

Product Variations

- ✓ Curved and shaped
- ✓ Single and multi-channel tensioning
- ✓ Optional anodised cover plate

Detailed Data Sheets

FLEX-C	FLEX-CC	FLEX-CC2	FLEX-CC4
FLEX-F	FLEX-F2	FLEX-165-STD	TENSION STRIPS

FLEX-C

- ✓ A basic channel profile for smaller displays up to 10sqm
- ✓ Uses smaller concealed countersunk fixings or rivets
- ✓ Ideal for fitting textiles and canvas to internal walls
- ✓ Suitable for retrofit to existing lightboxes



▶ Profile

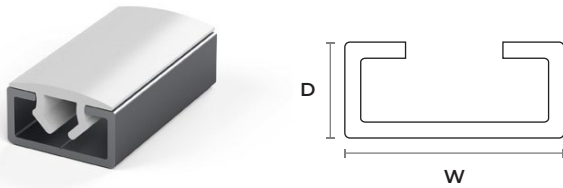

▶ Example Fitting

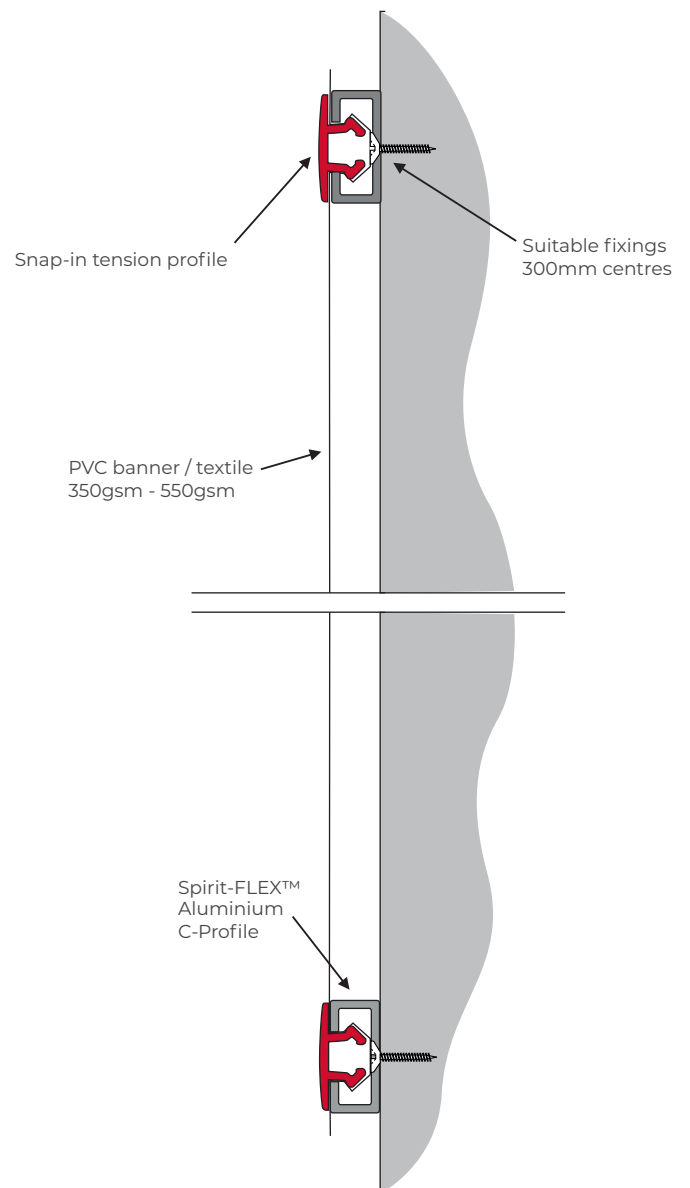

▶ Specifications

Material

Aluminium 6063 T6

Dimensions

Width: 22mm

Depth: 11mm

Length: 3060mm

Finish

- Mill
- Other finishes available

Compatible Parts

- Snap-in tension profile



FLEX-CC & Cover

- ✓ A double channel profile for medium to large displays
- ✓ Centralised fixing point improves stability on uneven surfaces
- ✓ For use on premium high-spec internal and external sites
- ✓ Compatible with the decorative snap-on cover plate



▶ Profile

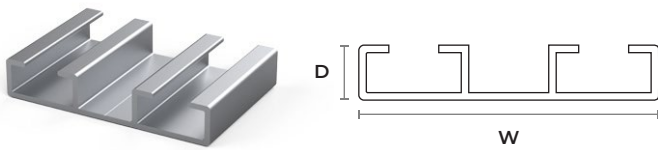

▶ Example Fitting

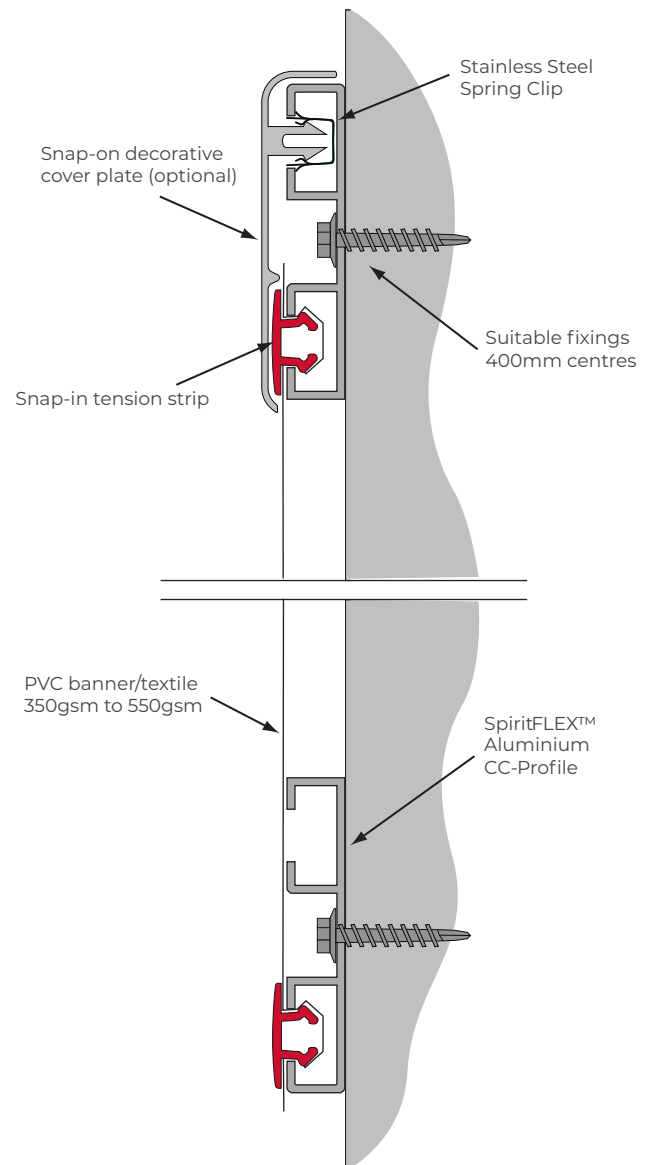

▶ Specifications

Material

Aluminium 6063 T6

Dimensions

Width: 60mm

Depth: 11mm

Length: 3060mm

Finish

- Mill
- Other finishes available

Compatible Parts

- Snap-in tension profile
- Snap-on **cover plate**
- Stainless steel spring-clips

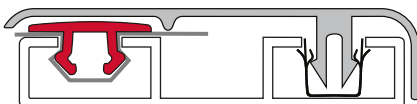

FLEX-CC2

- ✓ A larger structural profile for use on bigger outdoor sites
- ✓ Spans gaps unsupported of up to 1 metre wide
- ✓ Ideal for use on corrugated cladding
- ✓ Compatible with the snap-on cover plate



▶ Profile

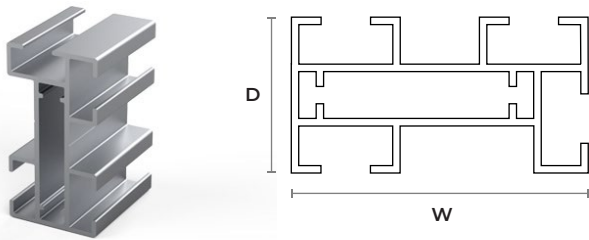

▶ Specifications

Material

Aluminium 6063 T6

Dimensions

Width: 60mm

Depth: 30mm

Length: 3060mm

Finish

- Mill
- Other finishes available

Compatible Parts

- Snap-in tension profile
- Snap-on **cover plate**
- Stainless steel spring-clips
- Connector brackets

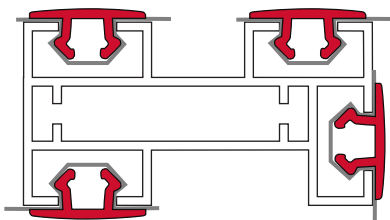

▶ Example Fitting

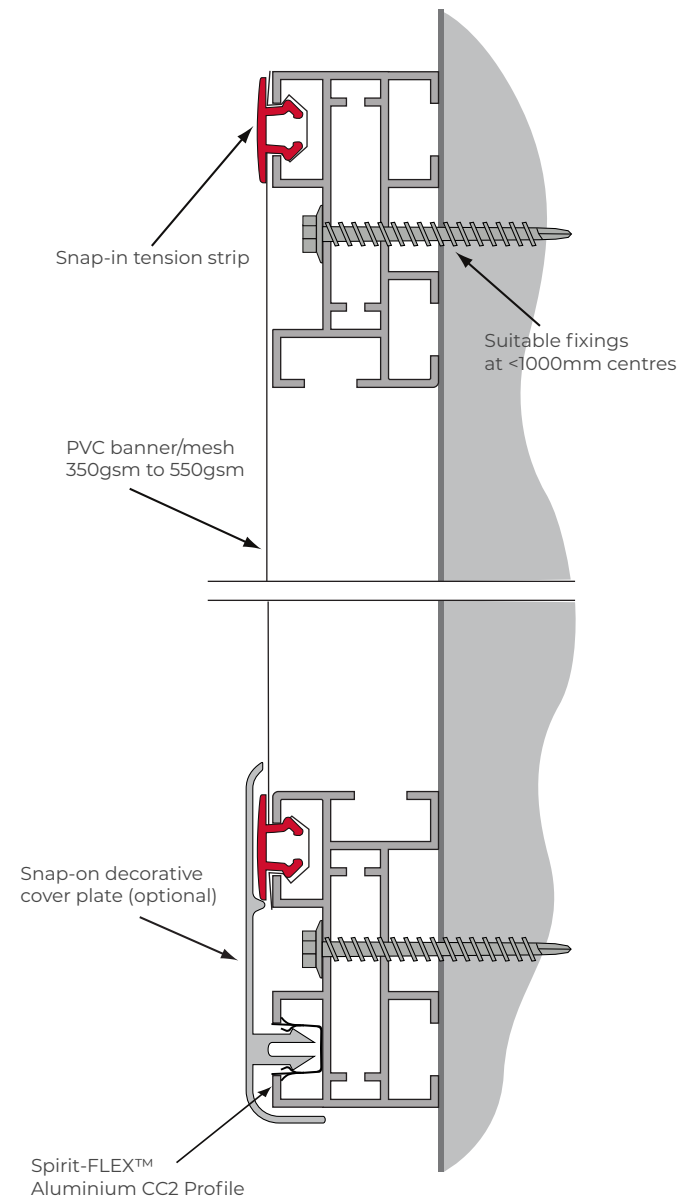

FLEX-CC4

- ✓ An extra large, structural profile for use on bigger outdoor sites
- ✓ Spans gaps unsupported up to 3 metres wide
- ✓ Ideal for use as temporary outdoor structures
- ✓ Great for building cladding



▶ Profile



3D Illustration

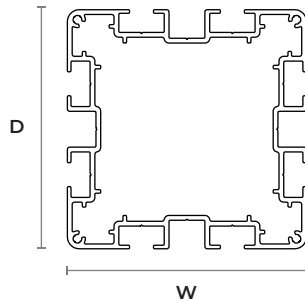

▶ Example Fitting

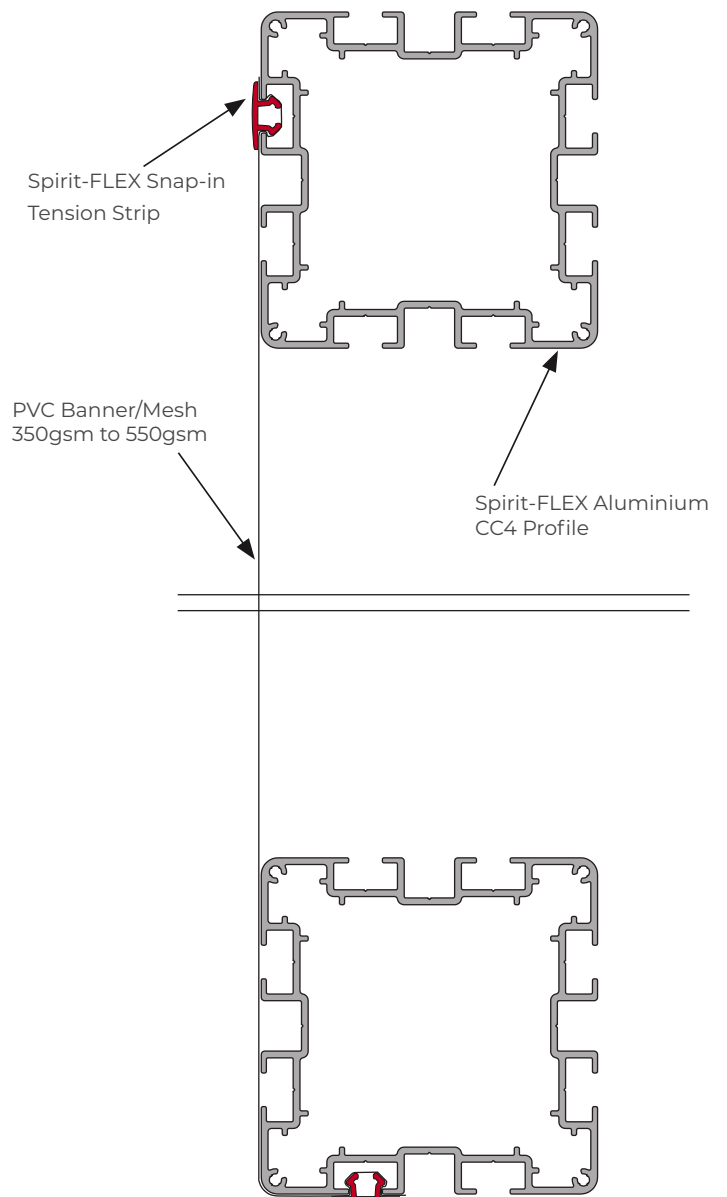

▶ Specifications

Material

Aluminium 6063 T6

Dimensions

Width: 100mm

Depth: 100mm

Length: 6130mm

Finish

- Mill
- Custom powder coat

Compatible Parts

- Snap-in tension profile
- CC2 Brace
- QuickBrace
- Corner connectors
- Spigot joiners

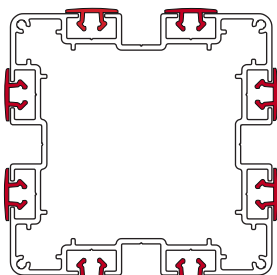

FLEX-F

- ✓ A versatile profile for use on a wide variety of surfaces
- ✓ The extra 18mm flange allows space for larger fixings
- ✓ Ideal for fixing and tensioning most banners and textiles
- ✓ Suitable for installing banners of more than 300sqm



▶ Profile

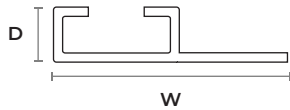
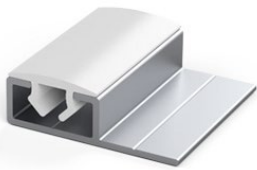

▶ Example Fitting

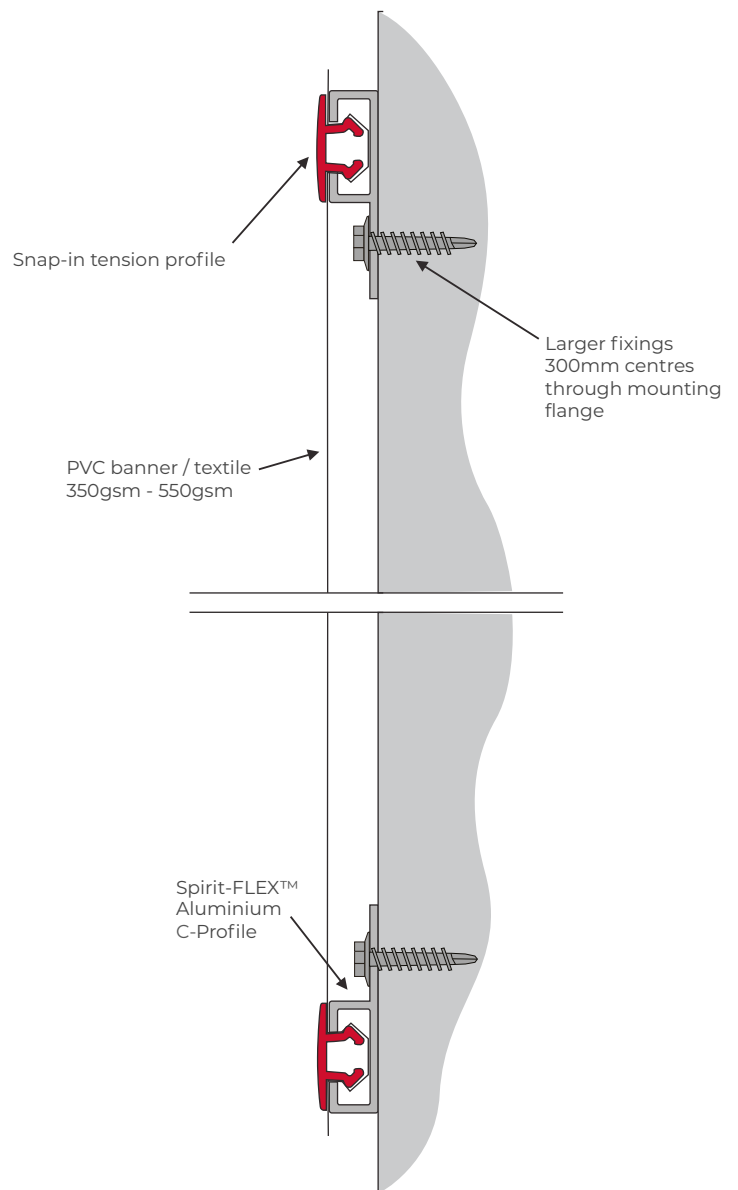

▶ Specifications

Material

Aluminium 6063 T6

Dimensions

Width: 40mm

Depth: 11mm

Length: 3060mm

Finish

- Mill
- Stock powder coat - black and white
- Other finishes available

Compatible Parts

- Snap-in tension profile
- Keder adapter profile
- 6mm Keder



FLEX-F2

- ✓ A versatile profile for use on a wide variety of surfaces
- ✓ The extra hollow section provides additional strength
- ✓ A good solution for aluminium cladding and plasterboard
- ✓ Suitable for installing banners of more than 300sqm



▶ Profile

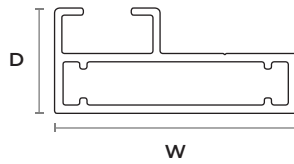

▶ Example Fitting

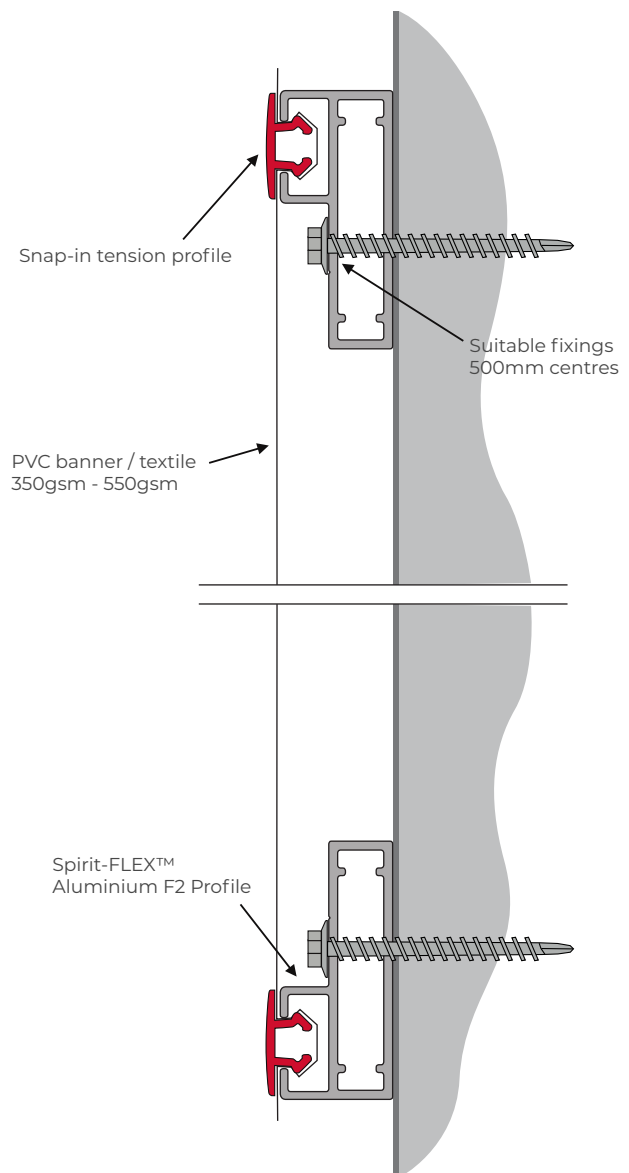

▶ Specifications

Material

Aluminium 6063 T6

Dimensions

Width: 50mm

Depth: 22mm

Length: 3060mm

Finish

- Mill
- Stock powder coat - black and white
- Other finishes available

Compatible Parts

- Snap-in tension profile
- Connector brackets

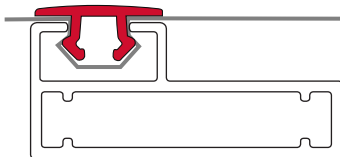

FLEX-165-STD

- ✓ Low-profile internally illuminated flexface lightbox
- ✓ 165mm deep accommodates various lighting options
- ✓ Indoor or outdoor use
- ✓ Easy to assemble for self-build or complete boxes with LEDs



▶ Profile

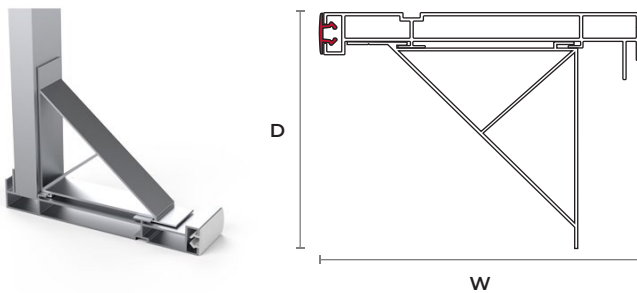

▶ Specifications

Material

Aluminium 6063 T6

Dimensions

Width: 40mm

Depth: 165mm

Length: 3060mm

Finish

- Mill
- Other finishes available

Compatible Parts

- Snap-in tension profile
- Support gusset
- Brace profile
- Connectors

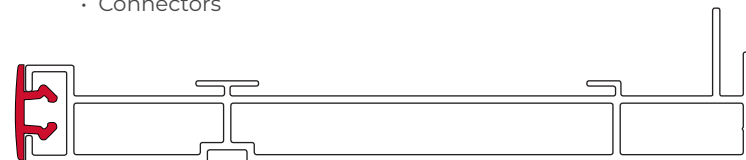

▶ Example Fitting

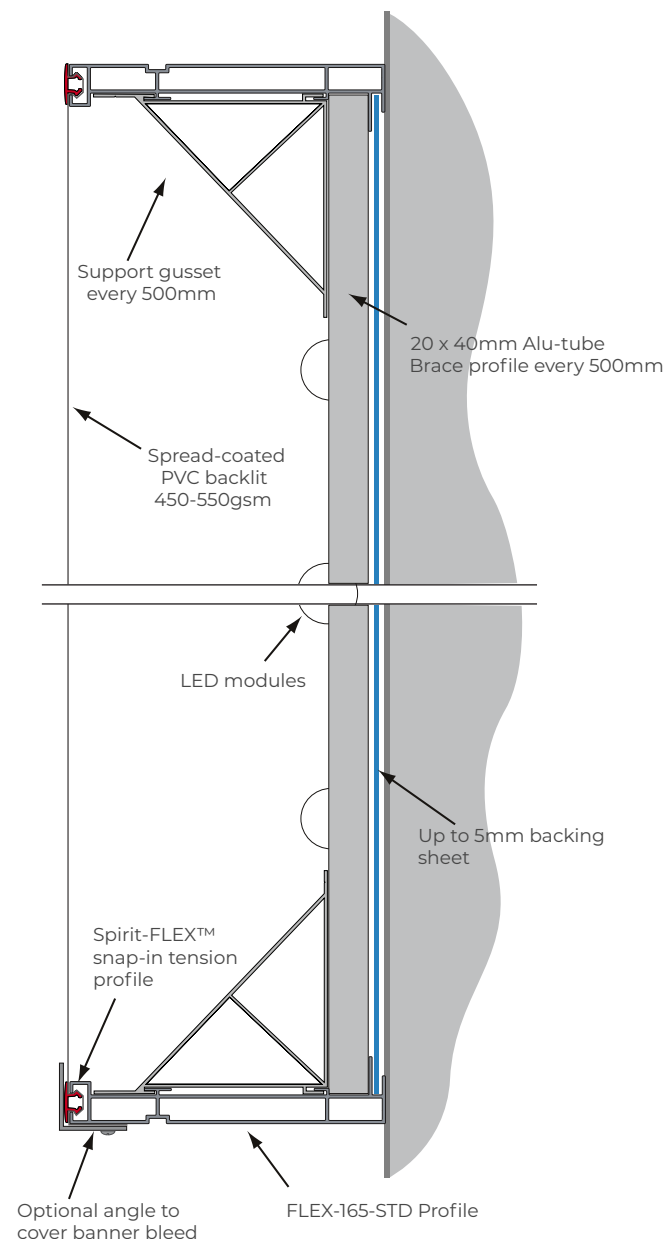

Tension Strip (Advanced & Regular)

- ✓ Advanced and regular material for different weather conditions
- ✓ Used for fixing and tensioning the banner into the channel
- ✓ Finishes the tensioned graphics with a neat 22mm trim edge
- ✓ Suitable for installing banners of more than 300sqm

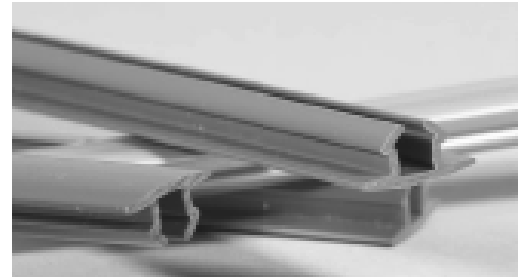

▶ Profile

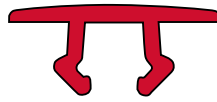
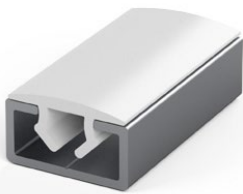

▶ Example Fitting

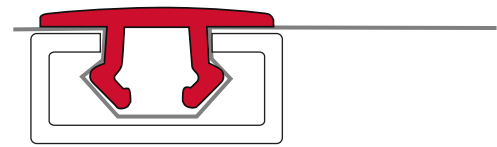

▶ Specifications

Colour

- Black
- White
- Grey
- Custom colour based on MOQ

Dimensions

Width: 22mm

Depth: 9.5mm

Use

- Advanced Tension Strip: Ideal for outdoor use
- Regular Tension Strip: Ideal for indoor use

Compatible Parts

- All Spirit-FLEX profiles

▶ Colours

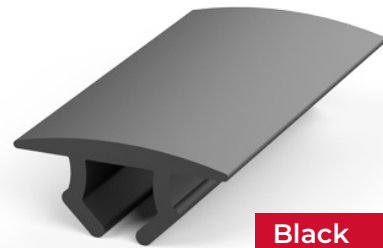

Black



White



Grey



About Spirit Displays

Partnering with our clients for over 15 years.

Spirit Displays fabricate custom aluminium frame systems for the graphics and signage industry, specialising in tailor-made solutions. We are a family-run company based in the UK, yet boasting a global reach with offices, warehousing facilities and distributors all over the world.

Who We Are

Innovative and Design Led

Being natural born problem-solvers and having a wealth of experience in the graphic display business, means we can confidently deliver complex projects others may shy away from, as well as, stock-in-trade solutions.

Service and Support Driven

We have a deep sense of duty to make sure our customers' projects are delivered on time and backed up by a supportive team. We work closely with our clients, lending our expertise and support from initial brief through to installation.

Commitment to Quality

Known for our quick turnaround and competitive pricing, we never compromise on the quality of our products. We are proud that our customers often comment that we build some of the best frames and lightboxes in the market.

What We Do

From LED light boxes and multi-panel wall displays, to 3D hanging signage and banner wraps for truck sides, Spirit Displays has a wide range of products which are known throughout the industry for their quality and innovative design. Our focus on research and development, provides continuous improvement to existing products, creation of new products and enables us to bring our clients effective but simple display solutions.

We also manufacture a range of systems for our global distributors, who are able to supply our products to their clients with complete confidence that they are backed by a company that has been built on the promise that we will always strive to deliver the best products to market.

What sets Spirit Displays apart is our flexibility when it comes to how we approach the challenges our clients face. Besides our standard offering, we offer custom-built display and signage solutions which, along with our extensive experience, allows our clients to achieve their individual objectives, whatever they might be.

We have a team of professional, friendly sales and support staff standing by to have a chat. You can contact us at our Head Office in London on +44 20 8684 0455, or [click here to contact us by email](#) and see how we can assist you with your display needs.

Contact Us

(Head Office – UK)

Unit 1, Lawson Hunt Industrial Park, Broadbridge Heath, West Sussex, RH12 3JR, United Kingdom

UK local: 0844 800 9612 | Int: +44 20 8684 0455

Email: info@spirit-displays.com

